



Equipment for the Foodservice Industry
value + quality + service

Chef-Base

CCB-52



CCB-52

Features

Features:

- Exterior & interior stainless steel construction
- Environmentally friendly R290 refrigerant
- Over sized, factory balanced refrigeration system using a heavy duty Embraco compressor
- Heavy duty stainless steel drawer slides and rollers; no tools required for drawer removal
- Magnetic drawer gasket is removable for easy cleaning and maintenance
- Pre-installed heavy duty castors with breakers, are included for added mobility
- Designed with corrosion-resistant stainless steel of the highest quality

- Gravity fed self-closing drawers

Warranty:

- One year parts and labour; Five years on compressor
- Specifications subject to change without notice



CCB-52

Specifications

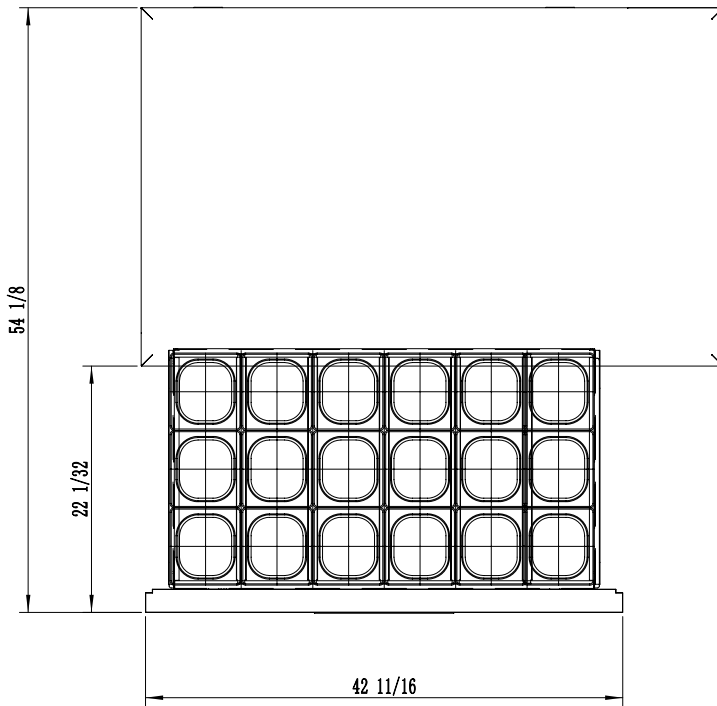
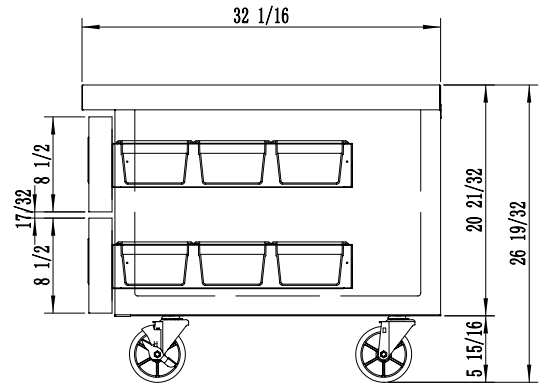
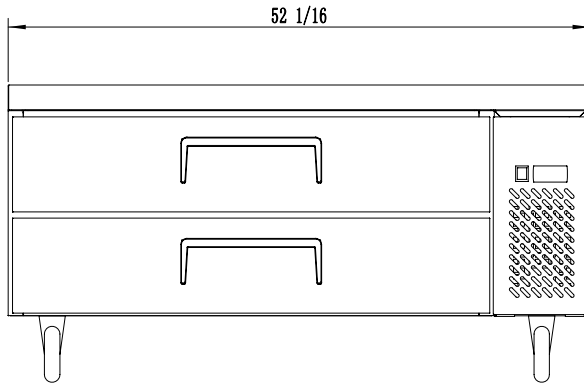

Model	Refrigerant	Drawers	Dimension (mm) (inch)			HP	Voltage	Amps	Capacity (L) (Cu Ft.)	Net Weight (KG) (LBS)	Temperature Range
			L	D	H						
CCB-52	R290	2	1323	815	520	1/6	115/60	2.3	238	104	1 ~ 3°C
			52.1	32.1	20.5				8.4	229	33 ~ 38°F