

## AR-7E ELECTRIC ROTISSERIE



• Operating at only 8.3 kilowatts, the Alto-Shaam rotisserie with EcoSmart™ technology uses very little electricity to cook a full load of delicious food.



AR-7E SHOWN WITH DOUBLE PANE, CURVED GLASS DOORS AND OPTIONAL NON-CONTROL SIDE PASS-THROUGH DOOR

- Temperature-dropping hold mode further saves on energy costs.
- Solid stainless steel back prevents further heat loss.
- Cook and hold in a single, counter-top rotisserie that features a combination of convection and radiant heat.
- A choice of one or two cooking stages for an improved finished product.
- Solid state electronic control has a clear, easy-to-read LED display to cook by time and features an automatic temperature reduction to a holding mode where product can remain until needed.
- Programmable control option with a seven program memory for both the cooking and holding function.
- The rotisserie can be stacked with an identical rotisserie oven or with a matching holding cabinet.
- Interior drip strips channel drippings into a bottom drip pan for convenient removal.
- Spits, rotating disks, drip strips are also removable for easy cleaning.
- Interior lighting is recessed to protect from breakage.

The Alto-Shaam electric rotisserie is constructed of a heavy gauge, non-magnetic stainless steel with a sealed cooking chamber for heat retention. Low-e glass on front includes a handle with magnetic door latch. Spit rotation is controlled by one (1) 1/2 hp motorized disk that provides an incremental rotation jog and automatic stop when door is opened. The cook temperature range is from 250° to 425°F (121° to 218°C). Additional electronic control features include temperature display in Fahrenheit or Celsius; a product hold key with a temperature range of 140° to 210°F (60° to 99°C), cooking set-points from 1 minute to 4 hours; and emergency stop. The rotisserie has a stainless steel exterior finish and is furnished with 4-inch legs.

- MODEL AR-7E:** Electric Rotisserie Oven, Single pane, flat door, solid back
- MODEL AR-7E:** Electric Rotisserie Oven, Double pane, curved glass, solid back

### FACTORY INSTALLED OPTIONS



ANSI/NSF 4



- Deluxe programmable control lets the operator set up to seven cooking programs for both cooking and holding functions.
- Panel Color Choices
  - ➔ Specify color choice:
    - Stainless Steel, standard
    - Black, optional
    - Burgundy, optional
    - Custom Color, optional

### ADDITIONAL FEATURES

- Multipurpose wire basket option handles irregular size products, denser items, or heavier products that require additional support.

- Reach-in compartment is standard.
  - ➔ Specify pass-through design as a special order.
    - Single pane, flat glass door
    - Double pane, curved glass door
- Right-hand door swing is standard
  - Specify left-hand door as a special order
- Ventless Hood  
(NOT AVAILABLE ON TWO STACKED ROTISSERIES)
- Optional handle on non-control side for pass-through use.
- Stackable options available.

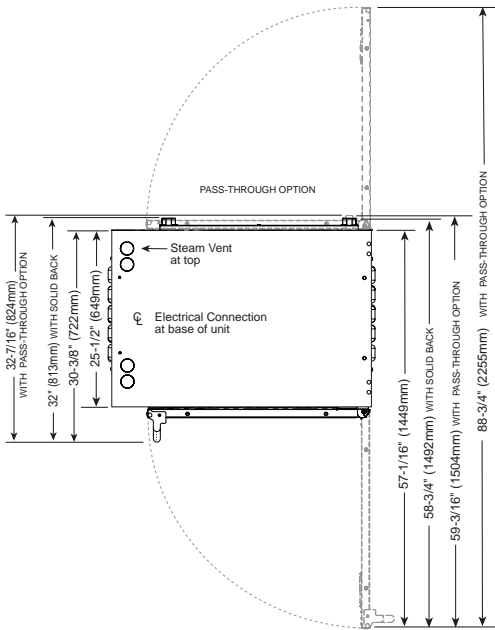

AR-7E WITH FLAT DOOR

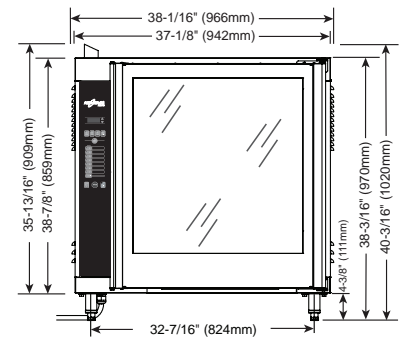
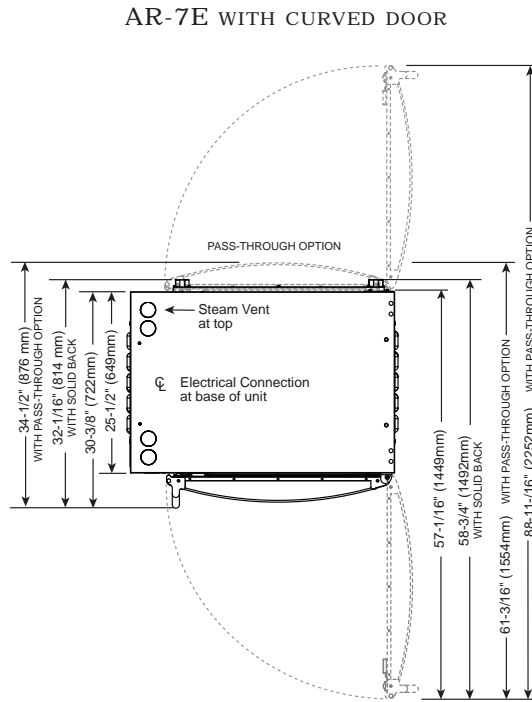

FRONT VIEW

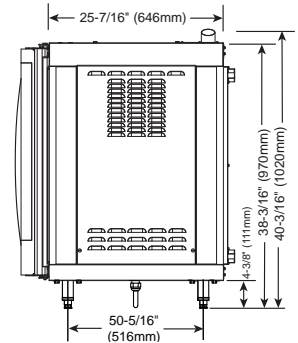

SIDE VIEW - DOUBLE PANE, CURVED DOOR, SOLID BACK

**NOTE — HEIGHT DIMENSION VARIANCE:**

- 2" (51mm) rubber feet add 2-1/8" (54mm) CE ONLY (FOR COUNTER TOP UNITS ONLY)
- 4" (102mm) legs add 4-3/8" (111mm)
- 5" (127mm) casters add 6-3/8" (162mm)
- 6" (152mm) legs add 6-3/8" (162mm)

<b>DIMENSIONS: H x W x D</b>						
<b>SINGLE PANE, FLAT GLASS</b>						
<b>EXTERIOR:</b>	40-3/16" x 38-1/16" x 32"			<b>PASS-THROUGH EXTERIOR (OPTION):</b>		
	(1020mm x 966mm x 813mm)			40-3/16" x 38-1/16" x 32-7/16"		
				(1020mm x 966mm x 824mm)		
<b>DOUBLE PANE, CURVED GLASS</b>						
<b>EXTERIOR:</b>	40-3/16" x 38-1/16" x 32-1/16"			<b>PASS-THROUGH EXTERIOR (OPTION):</b>		
	(1020mm x 966mm x 814mm)			40-3/16" x 38-1/16" x 34-1/2"		
				(1020mm x 966mm x 876mm)		
<b>INSTALLATION REQUIREMENTS</b>						
<ul style="list-style-type: none"> <li>• Oven must be installed level.</li> <li>• Exhaust ventilation is required</li> <li>• Install on a non-combustible surface only</li> <li>• The oven must not be installed in any area where it may be affected by steam, grease, dripping water, high temperatures, or any other severely adverse conditions.</li> <li>• In order to maintain NSF standards, counter models must be sealed at the bottom by an NSF approved sealant or equipped with 4" (102mm) legs.</li> </ul>						
<b>ELECTRICAL</b>						
VOLTAGE	PHASE	CYCLE/HZ	AMPS	kW		
208	1	60	40.0	8.3		
230	1	60	42.0	9.0		
240	1	60	38.0	8.8		
208	3	60	33.0/ph	8.3		
230	3	60	35.0/ph	9.0		
240	3	60	32.0/ph	8.8		
380-415	3	50/60	24.0/ph MAX	8.8 MAX		NO CORD NO PLUG
<b>PRODUCT CAPACITY</b>						
98 lb (44 kg) MAXIMUM						
<b>CLEARANCE REQUIREMENTS</b>						
6" (152mm) left, right, and rear sides						
<b>WEIGHT</b>						
NET: 361 lb (164 kg) SHIP: 540 lb (245 kg)						
<b>CRATE DIMENSIONS: (H x W x D)</b>						
49" x 50" x 45" EST. (1245mm x 1270mm x 1143mm)						
<b>ELECTRICAL</b>						
<b>ANGLED SPITS (STANDARD):</b>						
Up to twenty-one (21) 3-1/2 lb chickens (1,6 kg)						
Up to twenty-eight (28) 2-1/2 to 3 lb chickens (1,1 to 1,4 kg)						
<b>PIERCING SPITS (OPTIONAL):</b>						
Up to twenty-eight (28) 2-1/2 to 3-1/2 lb chickens (1,1 to 1,6 kg)						
<b>TURKEY SPIT (OPTIONAL):</b>						
One (1) Turkey up to 25 lb (11 kg)						

# ELECTRIC ROTISSERIE **AR-7E**

## STANDARD ACCESSORIES

- Seven (7) removable stainless steel angled spits
- Two (2) removable stainless steel angled drip strips
- One (1) removable stainless steel drip pan with drain, 2" (51mm) deep
- Six (6) 20 watt recessed bulbs

## OPTIONS & ACCESSORIES

<table style="width: 100%; border-collapse: collapse;"> <tr> <td style="border-bottom: 1px solid black;"><input type="checkbox"/> <b>CASTERS, 5" (127mm)</b> 4007 <small>NOT AVAILABLE WITH VENTLESS HOOD STACKED UNITS</small></td> </tr> <tr> <td style="border-bottom: 1px solid black;"><b>DOOR OPTIONS</b></td> </tr> <tr> <td style="border-bottom: 1px solid black;"><input type="checkbox"/> SINGLE PANE FLAT GLASS WITH HANDLE 5007012</td> </tr> <tr> <td style="border-bottom: 1px solid black;"><input type="checkbox"/> SINGLE PANE FLAT GLASS WITHOUT HANDLE 5007013</td> </tr> <tr> <td style="border-bottom: 1px solid black;"><input type="checkbox"/> <b>DOOR HANDLE, NON-CONTROL SIDE</b> HD-26900</td> </tr> <tr> <td style="border-bottom: 1px solid black;"><input type="checkbox"/> <b>DRIP PAN, STAINLESS STEEL</b> 1001976</td> </tr> <tr> <td style="border-bottom: 1px solid black;"><b>DRIP PAN TRAY, DOOR MOUNTED</b></td> </tr> <tr> <td style="border-bottom: 1px solid black;"><input type="checkbox"/> FLAT GLASS DOOR 5004859</td> </tr> <tr> <td style="border-bottom: 1px solid black;"><input type="checkbox"/> CURVED GLASS DOOR 1002598</td> </tr> <tr> <td style="border-bottom: 1px solid black;"><input type="checkbox"/> <b>FEET, RUBBER, 2" (51mm) CE ONLY</b> 5001614 <small>FOR COUNTER TOP UNITS ONLY</small></td> </tr> <tr> <td style="border-bottom: 1px solid black;"><b>LEGS</b></td> </tr> <tr> <td style="border-bottom: 1px solid black;"><input type="checkbox"/> 4" (102mm) ASSEMBLY 5001765</td> </tr> <tr> <td style="border-bottom: 1px solid black;"><input type="checkbox"/> 6" (152mm) ASSEMBLY 5001414</td> </tr> <tr> <td style="border-bottom: 1px solid black;"><input type="checkbox"/> 6" (152mm) ASSEMBLY, FLANGED FEET 5001761 <small>REQUIRED FOR STACKING UNITS.</small></td> </tr> <tr> <td style="border-bottom: 1px solid black;"><input type="checkbox"/> <b>MULTI-PURPOSE WIRE BASKET</b> (.50 dia. pin)BS-26019</td> </tr> </table>	<input type="checkbox"/> <b>CASTERS, 5" (127mm)</b> 4007 <small>NOT AVAILABLE WITH VENTLESS HOOD STACKED UNITS</small>	<b>DOOR OPTIONS</b>	<input type="checkbox"/> SINGLE PANE FLAT GLASS WITH HANDLE 5007012	<input type="checkbox"/> SINGLE PANE FLAT GLASS WITHOUT HANDLE 5007013	<input type="checkbox"/> <b>DOOR HANDLE, NON-CONTROL SIDE</b> HD-26900	<input type="checkbox"/> <b>DRIP PAN, STAINLESS STEEL</b> 1001976	<b>DRIP PAN TRAY, DOOR MOUNTED</b>	<input type="checkbox"/> FLAT GLASS DOOR 5004859	<input type="checkbox"/> CURVED GLASS DOOR 1002598	<input type="checkbox"/> <b>FEET, RUBBER, 2" (51mm) CE ONLY</b> 5001614 <small>FOR COUNTER TOP UNITS ONLY</small>	<b>LEGS</b>	<input type="checkbox"/> 4" (102mm) ASSEMBLY 5001765	<input type="checkbox"/> 6" (152mm) ASSEMBLY 5001414	<input type="checkbox"/> 6" (152mm) ASSEMBLY, FLANGED FEET 5001761 <small>REQUIRED FOR STACKING UNITS.</small>	<input type="checkbox"/> <b>MULTI-PURPOSE WIRE BASKET</b> (.50 dia. pin)BS-26019	<table style="width: 100%; border-collapse: collapse;"> <tr> <td style="border-bottom: 1px solid black;"><b>SPITS</b></td> </tr> <tr> <td style="border-bottom: 1px solid black;"><input type="checkbox"/> ANGLED SPIT, STAINLESS STEEL SI-25934</td> </tr> <tr> <td style="border-bottom: 1px solid black;"><input type="checkbox"/> PIERCING SPIT, STAINLESS STEEL SI-25729</td> </tr> <tr> <td style="border-bottom: 1px solid black;"><input type="checkbox"/> TURKEY SPIT, STAINLESS STEEL SI-26980</td> </tr> <tr> <td style="border-bottom: 1px solid black;"><input type="checkbox"/> ANGLED SPIT, TEFLON COATED 5001335</td> </tr> <tr> <td style="border-bottom: 1px solid black;"><b>STACKING ASSEMBLY (FACTORY INSTALLED)</b></td> </tr> <tr> <td style="border-bottom: 1px solid black;"><input type="checkbox"/> AR-7E OVER AR-7E (208-240V, 1PH) 5006291</td> </tr> <tr> <td style="border-bottom: 1px solid black;"><input type="checkbox"/> AR-7E OVER AR-7H (208-240V, 1PH) 5008787</td> </tr> <tr> <td style="border-bottom: 1px solid black;"><input type="checkbox"/> AR-7E OVER AR-7H (208-240V, 3PH) 5008948</td> </tr> <tr> <td style="border-bottom: 1px solid black;"><input type="checkbox"/> AR-7E OVER AR-7H (380-415V) 5008922</td> </tr> <tr> <td style="border-bottom: 1px solid black;"><b>STAND, STAINLESS STEEL</b></td> </tr> <tr> <td style="border-bottom: 1px solid black;"><input type="checkbox"/> WITH STORAGE SHELF FR-26550</td> </tr> <tr> <td style="border-bottom: 1px solid black;"><input type="checkbox"/> OPEN (AR-7E OVER 750-S) 5002058</td> </tr> <tr> <td style="border-bottom: 1px solid black;"><b>TEFLON® COATED ACCESSORIES - COMMERCIAL GRADE</b></td> </tr> <tr> <td style="border-bottom: 1px solid black;"><input type="checkbox"/> INCLUDES DISKS, DRIP TRAY AND 7 ANGLED SPITS 5001302</td> </tr> </table>	<b>SPITS</b>	<input type="checkbox"/> ANGLED SPIT, STAINLESS STEEL SI-25934	<input type="checkbox"/> PIERCING SPIT, STAINLESS STEEL SI-25729	<input type="checkbox"/> TURKEY SPIT, STAINLESS STEEL SI-26980	<input type="checkbox"/> ANGLED SPIT, TEFLON COATED 5001335	<b>STACKING ASSEMBLY (FACTORY INSTALLED)</b>	<input type="checkbox"/> AR-7E OVER AR-7E (208-240V, 1PH) 5006291	<input type="checkbox"/> AR-7E OVER AR-7H (208-240V, 1PH) 5008787	<input type="checkbox"/> AR-7E OVER AR-7H (208-240V, 3PH) 5008948	<input type="checkbox"/> AR-7E OVER AR-7H (380-415V) 5008922	<b>STAND, STAINLESS STEEL</b>	<input type="checkbox"/> WITH STORAGE SHELF FR-26550	<input type="checkbox"/> OPEN (AR-7E OVER 750-S) 5002058	<b>TEFLON® COATED ACCESSORIES - COMMERCIAL GRADE</b>	<input type="checkbox"/> INCLUDES DISKS, DRIP TRAY AND 7 ANGLED SPITS 5001302
<input type="checkbox"/> <b>CASTERS, 5" (127mm)</b> 4007 <small>NOT AVAILABLE WITH VENTLESS HOOD STACKED UNITS</small>																															
<b>DOOR OPTIONS</b>																															
<input type="checkbox"/> SINGLE PANE FLAT GLASS WITH HANDLE 5007012																															
<input type="checkbox"/> SINGLE PANE FLAT GLASS WITHOUT HANDLE 5007013																															
<input type="checkbox"/> <b>DOOR HANDLE, NON-CONTROL SIDE</b> HD-26900																															
<input type="checkbox"/> <b>DRIP PAN, STAINLESS STEEL</b> 1001976																															
<b>DRIP PAN TRAY, DOOR MOUNTED</b>																															
<input type="checkbox"/> FLAT GLASS DOOR 5004859																															
<input type="checkbox"/> CURVED GLASS DOOR 1002598																															
<input type="checkbox"/> <b>FEET, RUBBER, 2" (51mm) CE ONLY</b> 5001614 <small>FOR COUNTER TOP UNITS ONLY</small>																															
<b>LEGS</b>																															
<input type="checkbox"/> 4" (102mm) ASSEMBLY 5001765																															
<input type="checkbox"/> 6" (152mm) ASSEMBLY 5001414																															
<input type="checkbox"/> 6" (152mm) ASSEMBLY, FLANGED FEET 5001761 <small>REQUIRED FOR STACKING UNITS.</small>																															
<input type="checkbox"/> <b>MULTI-PURPOSE WIRE BASKET</b> (.50 dia. pin)BS-26019																															
<b>SPITS</b>																															
<input type="checkbox"/> ANGLED SPIT, STAINLESS STEEL SI-25934																															
<input type="checkbox"/> PIERCING SPIT, STAINLESS STEEL SI-25729																															
<input type="checkbox"/> TURKEY SPIT, STAINLESS STEEL SI-26980																															
<input type="checkbox"/> ANGLED SPIT, TEFLON COATED 5001335																															
<b>STACKING ASSEMBLY (FACTORY INSTALLED)</b>																															
<input type="checkbox"/> AR-7E OVER AR-7E (208-240V, 1PH) 5006291																															
<input type="checkbox"/> AR-7E OVER AR-7H (208-240V, 1PH) 5008787																															
<input type="checkbox"/> AR-7E OVER AR-7H (208-240V, 3PH) 5008948																															
<input type="checkbox"/> AR-7E OVER AR-7H (380-415V) 5008922																															
<b>STAND, STAINLESS STEEL</b>																															
<input type="checkbox"/> WITH STORAGE SHELF FR-26550																															
<input type="checkbox"/> OPEN (AR-7E OVER 750-S) 5002058																															
<b>TEFLON® COATED ACCESSORIES - COMMERCIAL GRADE</b>																															
<input type="checkbox"/> INCLUDES DISKS, DRIP TRAY AND 7 ANGLED SPITS 5001302																															



### STACKING COMBINATION

AR-7VH VENTLESS HOOD OVER  
AR-7E ROTISSERIE

### STACKING COMBINATIONS (FACTORY INSTALLED)

#### AR-7VH ventless hood *over* AR-7E rotisserie

Requires 4" (102mm) legs for counter top applications. Free standing floor installations require 6" (152mm) leg assembly **5001414** or 5" (127mm) casters **4007**.  
(OVERALL HEIGHT: 54-7/16")

#### AR-7E rotisserie *over* AR-7E rotisserie

Requires 6" (152mm) leg assembly **5001414** or 5" (127mm) casters **4007** and stacking assembly **5006291** for applications within the United States. Applications outside the U.S. requires 6" (152mm) legs with flanged feet **5001761** bolted to the floor.  
(OVERALL HEIGHT: 76-7/8")

#### AR-7E rotisserie *over* AR-7H companion holding cabinet

Requires 6" (152mm) leg assembly **5001414** or 5" (127mm) casters **4007** and stacking assembly (**5008787**, **5008948** or **5008922** - depending on voltage - see list above) for applications within the United States. Applications outside the U.S. requires 6" (152mm) legs with flanged feet **5001761** bolted to the floor.  
(OVERALL HEIGHT: 76-7/8")

#### AR-7VH ventless hood *over* AR-7E rotisserie *over* AR-7H companion holding cabinet

Requires 6" (152mm) legs with flanged feet **5001761** bolted to the floor.  
(OVERALL HEIGHT: 90-13/16")



W164 N9221 Water Street • P.O. Box 450 • Menomonee Falls, Wisconsin 53052-0450 • U.S.A.  
PHONE: 262.251.3800 800.558.8744 U.S.A./CANADA FAX: 262.251.7067 800.329.8744 U.S.A. ONLY

[www.alto-shaam.com](http://www.alto-shaam.com)

AR-7VH WITH CURVED DOOR

AR-7VH WITH FLAT DOOR



AR-7VH VENTLESS HOOD  
INSTALLED DIRECTLY ON THE TOP OF  
ELECTRIC ROTISSERIE MODEL AR-7E

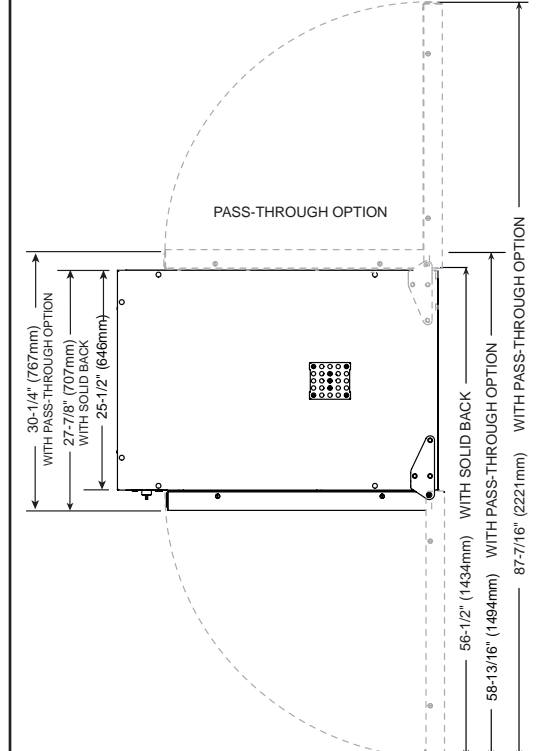
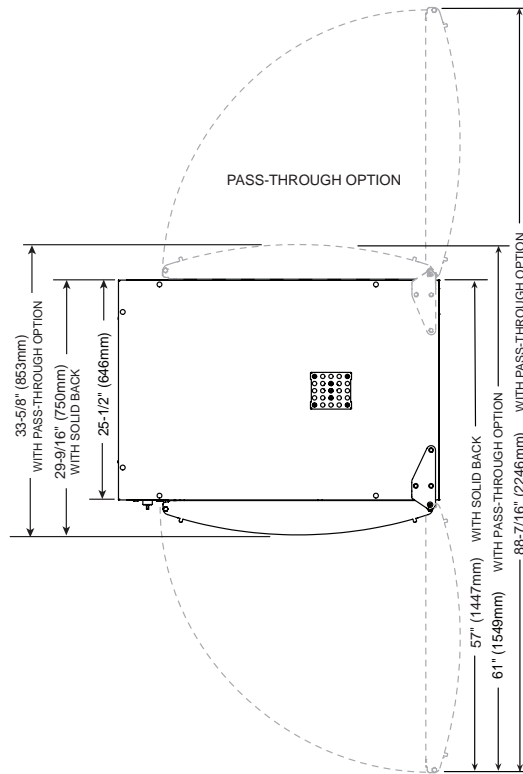

**UL** LISTED  
COOKING APPLIANCE  
584m

LISTED  
COOKING APPLIANCE  
WITH INTEGRAL SYSTEMS  
FOR LIMITING THE EMISSION  
OF GREASE LADEN AIR  
1P35

ALSO CLASSIFIED BY  
UNDERWRITERS  
LABORATORIES INC.®  
IN ACCORDANCE WITH  
NSF4 - 2002

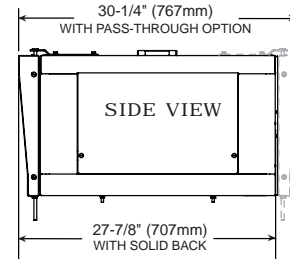
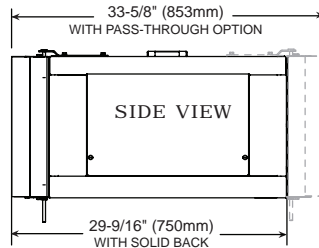
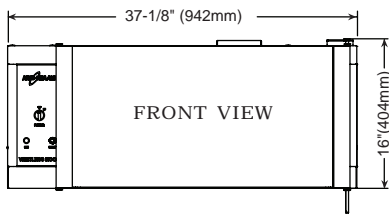

DIMENSIONS: H x W x D			
FLAT GLASS		CURVED GLASS	
EXTERIOR: 16" x 37-1/8" x 27-7/8" (404mm x 942mm x 707mm)	PASS-THROUGH EXTERIOR: (OPTION) 16" x 37-1/8" x 30-1/4" (404mm x 942mm x 767mm)	EXTERIOR: 16" x 37-1/8" x 29-9/16" (404mm x 942mm x 750mm)	PASS-THROUGH EXTERIOR: (OPTION) 16" x 37-1/8" x 33-5/8" (404mm x 942mm x 853mm)
<b>ELECTRICAL</b>		<b>AIR MOVEMENT</b>	
VOLTAGE	PHASE	CYCLE/HZ	AMPS
208-240	1	50/60	1.0
kW		530 cfm (15m <sup>3</sup> )	
.2		<b>CLEARANCE REQUIREMENTS</b>	
<b>INSTALLATION REQUIREMENTS</b>		6" (152mm) at top, back and both sides	
FACTORY INSTALLATION ONLY		<b>WEIGHT</b>	
The ventless hood must not be installed in any area where it may be affected by steam, grease, dripping water, high temperatures, or any other severely adverse conditions. (NOT AVAILABLE ON TWO STACKED ROTISSERIES)		NET: 120 lb (54 kg)	
<b>OPTIONS &amp; ACCESSORIES</b>		SHIP: 175 lb (79 kg) ADDITIONAL SHIP WEIGHT	
Replacement Filters		FACTORY INSTALLED OVER AR-7E ROTISSERIE	
<input type="checkbox"/> Grease Filter	FI-25867	CRATE DIMENSIONS: 62" x 50" x 45" EST.	
<input type="checkbox"/> Charcoal Filter	FI-25866	(H x W x D)	
		(1575mm x 1270mm x 1143mm)	